

UPDATED  
12 APRIL 2013

# DURHAM FAMILY HISTORY

## THE BARDOE FAMILY COBHAM and NORTHFLEET, KENT

page 4  
Martin  
Bilboe, Bardoe  
family tree

Page 1

### NOTE

- the author previously considered Joseph I and George III's families as the Elder and Younger Lines respectively, but since the images of the baptism records have come online, it is apparent that George III was older than Joseph I, so George III's family is now considered the Elder Line, and Joseph I's the Younger Line – the tree has been rearranged to reflect this
- this is only a simplified family tree, designed primarily to show the author's ancestors and the large Bardoe family, but is by no means complete or fully updated - up-to-date information can be found in various trees on Ancestry and GenesReunited

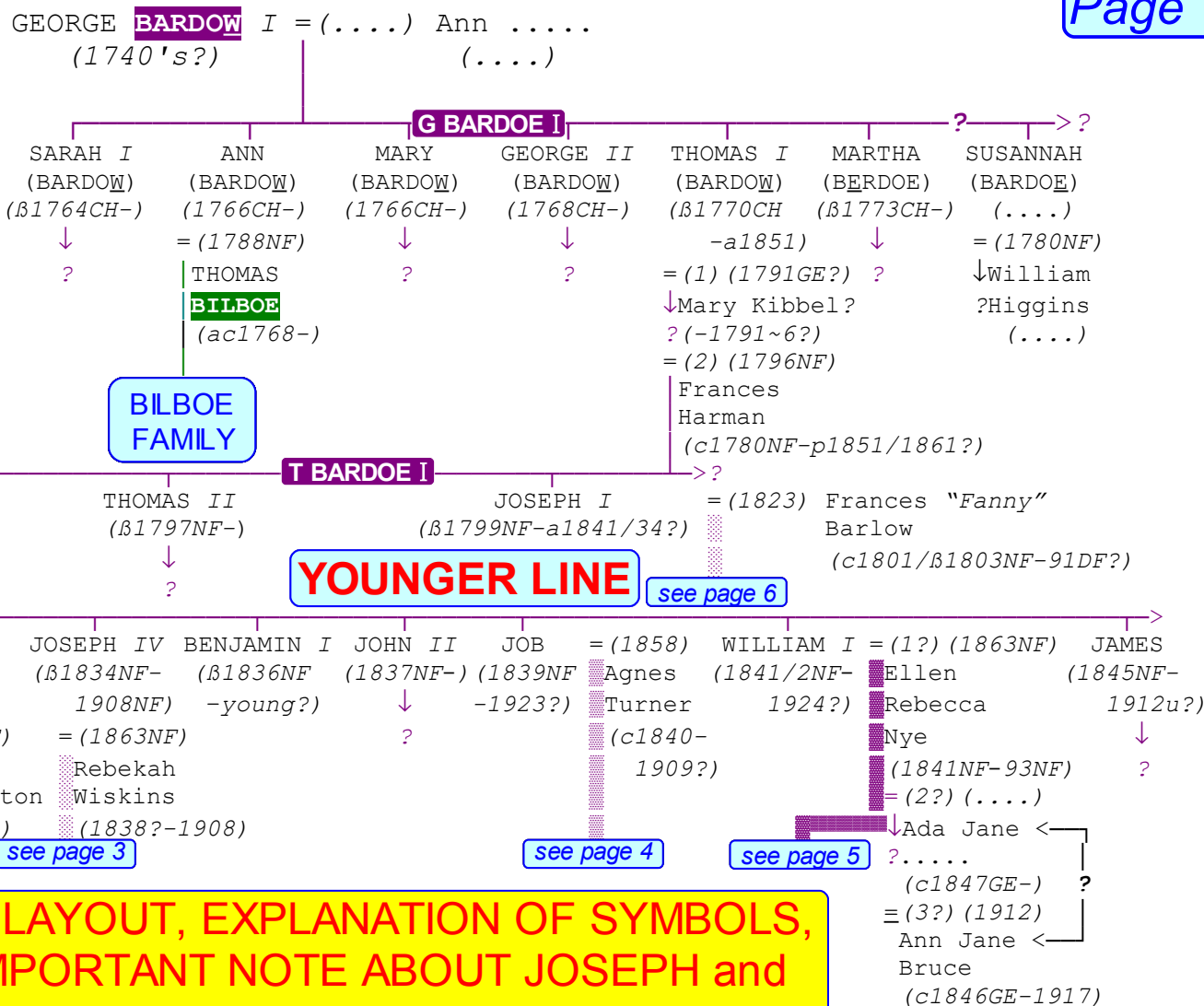

FOR PAGE LAYOUT, EXPLANATION OF SYMBOLS,  
AND AN IMPORTANT NOTE ABOUT JOSEPH and  
GEORGE BARDOES, SEE LAST PAGE

5

5

6

6

**T BARDOE IV**

**G BARDOE IV**

**T BARDOE IV**

GEORGE VI = (1874) (1852NF-1931)	REBECCA = (1879GE) MARTHA (1854GW-)	CHARLES = (1883) JOSEPH (1859L-1942)	MATILDA I = (1885L) (1862NF-)	HENRY = (1887NF) JAMES I (1867NF-)	CLARA = (1) (1890L) = (2) (1903L) AGNES (1870NF-)	Walter COOMBES (c1854-1900)	John Albert LLOYD (c1874-)
Elizabeth Hart (c1855DF-1931?)	David HART I (c1851L-)	Mary Ann Page c1855-1941?)	William Thomas Joseph HARRISON (c1862L-)	Ellen Read (c1867/71-)			

not found in 1911 census

total 5 or 6 children by 1911 census, all alive

no children of their own

total 8 children by 1911 census, 2 already dead

not found in 1911 census

total 2 children by 1911 census, both alive

Page 2

**CJ BARDOE HARRISON**

**HJ BARDOE I COOMBES**

**LLOYD**

Ellen Read (page 2) and Rose Read (page 11) were most probably sisters

**T BARDOE IV**

ELLEN I (1856NF-) = (1882NF) Frederick DRAPER (c1859-)	ELIZABETH (1859NF-1906NF) (1) = (1879NF) John APPS I (c1858-)	JOHN THOMAS (1860NF-1)	ADAM (1862NF-78NF)	CALEB (1864NF-1944) = (1893GE) Sarah Jane Humphrey (1871-1943)	EDITH (1866NF-1948GE?) = (1897NF) Thomas James Friend (c1866NF-1945NF?)	WALTER (1867NF-1923) ↓ ?	FLORENCE ELLEN (1872NF-3)	ELIZA MARY (1874NF-) = (1897GE) Thomas Frederick BARTON (c1869GE-)	ADA FLORENCE (1877NF-1958NF) = (1903NF) Arthur FRIEND (c1868NF-1938NF)
---	--	------------------------	--------------------	---	--	--------------------------------	---------------------------	---	---

total 4 children by 1911 census, 1 already dead

total 4 children by 1911 census, all alive

no children by 1911 census

total 4 children by 1911 census, 3 already dead

total 3 children by 1911 census, all alive

**BARTON**  
**CAL. BARDOE**  
**J APPS I**

**F DRAPER**

**LLOYD**

**COOMBES**

**HART**

**CJ BARDOE**

**HARRISON**

**HJ BARDOE I**

CLARA EMILY (1875NF-1902) Walter William KNIGHT (c1880-)	GEORGE JAMES (1876NF-83SC)	MATILDA REBECCA (1879SC-1906) Sidney Caiger KENT (c1882-)	Mary C.... (c1880NF-) Matilda (c1881NF-) ?	Mary Ellen (c1885NF-) David II (c1889-) ?	George (c1892NF-) Catherine (c1895-) ?	Caroline May Dicker [adopted] (c1905-)	George Woods (c1887-) Annie E.... (c1889NF-) ?	Walter William (c1890L-) Nellie Matilda (c1892L-) ↓ ?	James Lewis (c1897L-) Joseph Albert (c1898L-) ↓ ?	2 children (-a1911)
--	----------------------------	---	--	---	--	--	--	---	---	---------------------

← total 3 children by 1911 census, 1 already dead

no children by 1911 census

**KENT**

**HJ BARDOE I**

**COOMBES**

**LLOYD**

**F DRAPER**

ELLEN MATILDA I (1888NF)	ELLEN MATILDA II (1889-90NF)	May Clara A.... (1891-)	Maud Matilda (1892-)	Ethel Violet (1895-)	George Frederick (1899-)	Eric James S.... (1906-)	Albert J.... (1910-)	Frederick Thomas I (1884NF-1908)	Caleb (c1886NF-)	Edith (c1888NF-94?)	Ernest (c1890NF-)
		↓ ?	↓ ?	↓ ?	↓ ?	↓ ?	↓ ?	↓ ?	↓ ?	↓ ?	↓ ?
								Florence Amy York (c1884L-)			

6

7

4

6

7

8

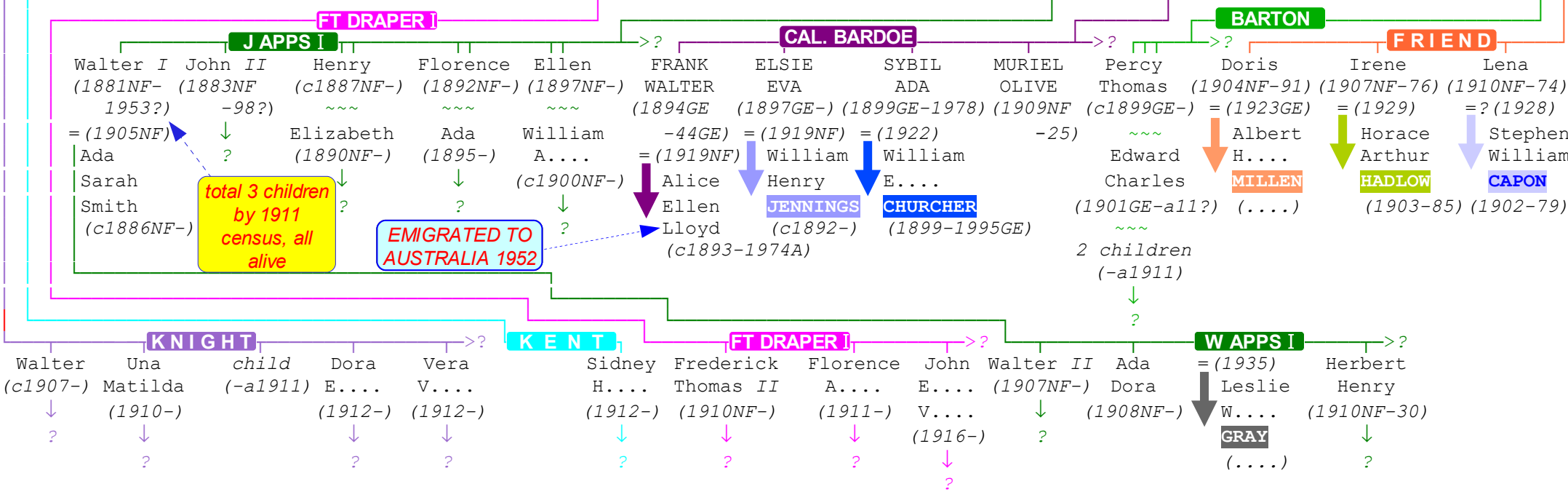

### JOSEPH BARDOE IV's FAMILY

see page 1

JOSEPH BARDOE IV = (1863NF) Rebekah Wiskins (B1834NF-1908NF) (1838?-1908)

total 2 children by 1911 census, both alive

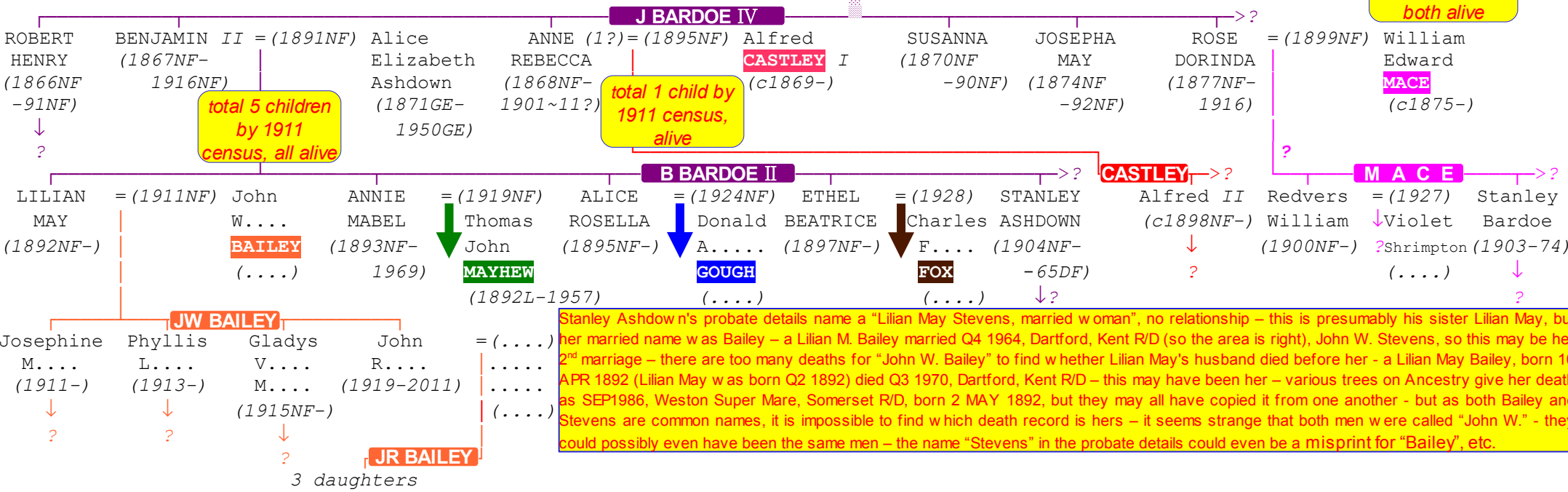

# JOB BARDOE's FAMILY

[see page 1](#)

JOB **BARDOE** = (1858) Agnes Turner  
(1839NF-1923?) (c1840-1909?)

4  
5

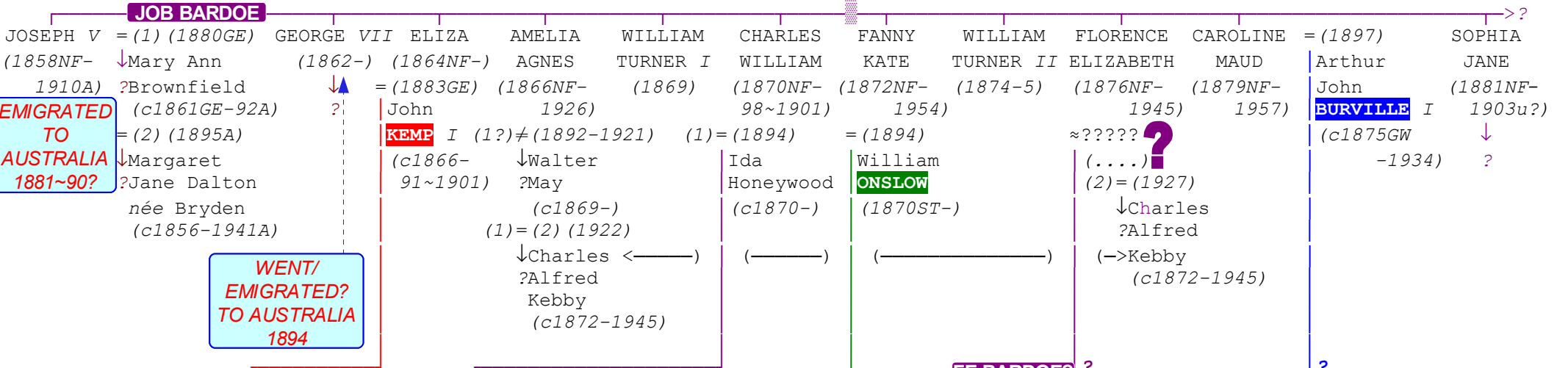

6

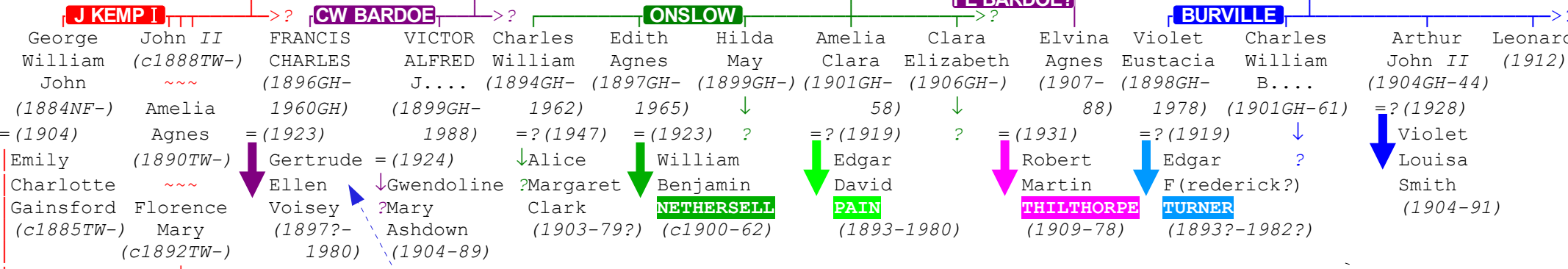

7

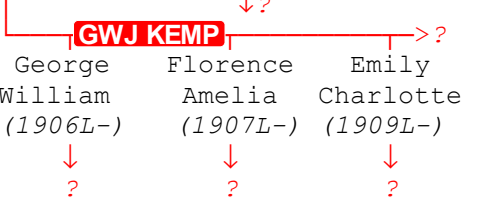

probably sister of Charles A(ustin?) Voisey see page 9

# WILLIAM BARDOE I's FAMILY

see page 1

WILLIAM BARDOE I = (1?) (1863NF) = (2?) (....) ≡ (3?) (1912)  
 (1841NF-1924?) Ellen  
 Rebecca  
 Nye (1841NF-93NF)

↓ Ada Jane ←-?-→ Ann Jane  
 ?..... Bruce  
 (c1847GE-) (c1846GE-1917)

**W BARDOE I**  
 ELLEN II (c1864NF-) (1865NF-1934) = (1886)  
 ALFRED (1865NF-1934) = (1892NF)  
 ANNIE (1866NF-) = (1897)  
 ERNEST (1869NF-1947NF) = (1890NF)  
 HONEST (1870NF-1917) (1)= (1898)  
 AMY (1872NF-1904L) = (1891)  
 NOBLE (1874NF-1948) = (1899)  
 RUTH (1875NF-1983C?) = (1897SC)  
 WELCOME (1878NF-1923) ↓

William Henry **COLLINS** (1861SC-)  
 Abigail Bright (1866NF-1942)  
 William Alfred **BURRIDGE** (c1868-1910?)  
 Annie Amy Larkin (c1872-1954)  
 ↓ Ada ?Britton later Collins (c1878-) (- **COLLINS** -)  
 Thomas **COLLINS** (c1870-)  
 Lily Mary Britton (c1880-1048)  
 Richard Alfred **WEST** (1874SC-1949C)  
 ?  
 Ada Britton, Lily Mary Britton (both page 4), and Susan Britton (page 10) were most probably sisters

total 6 children by 1911 census, all alive  
 total 5 children by 1911 census, 1 already dead  
 total 2 children by 1911 census, 1 already dead  
 total 3 children by 1911 census, all alive  
 no children by 1911 census  
 total 4 children by 1911 census, all alive  
 EMIGRATED TO CANADA 1908  
**WEST**  
**N BARDOE**  
**T COLLINS**  
**E BARDOE**  
**BURRIDGE**

**WH COLLINS** Ellen (c1887SC-) ↓ ?  
 William (c1889SC-) ↓ ?  
 Alfred (c1892SC-) ↓ ?  
 Annie (c1894-) ↓ ?  
 Walter (c1900-) ↓ ?  
 Frank (c1907-) ↓ ?  
**A BARDOE** ALFRED GEORGE (1893NF-1969) = (1920) ↓ Evelyn Wright (c1890-1968)  
 WILLIAM II (1895NF-1969) ↓ ?  
 EVA ELSIE (1897NF-) = (1928) ↓ George Merritt (....)  
 NOBLE JOHN (1898NF-75) = (1?) (1931) ↓ Aileen Parr (c1903-1962) = (2?) (1971) ↓ Florence ?Bardoe (née .....?) (....)  
**BURRIDGE** Sydney William (1898-) ↓ ?  
 Stanley (1900-1) → ?

**E BARDOE** ANNIE AMY (1892NF-) ↓  
 Francis A.... **CARTER** I (....)  
 ERNEST WILLIAM I (1896NF-1952) ↓  
 Elsie Elizabeth Husbands (c1896-1956DF)  
 ROLAND HAROLD (1903-76) ↓ ?  
 CYRIL HUGH (1912-84) ↓ ?  
 = (1937) Florence Isabel Exeter (1908-93)  
**T COLLINS** Amy (c1896-) ↓ ?  
 Ruth (c1898-) ↓ ?  
 Baden Powell (1900-) ↓ ?

6

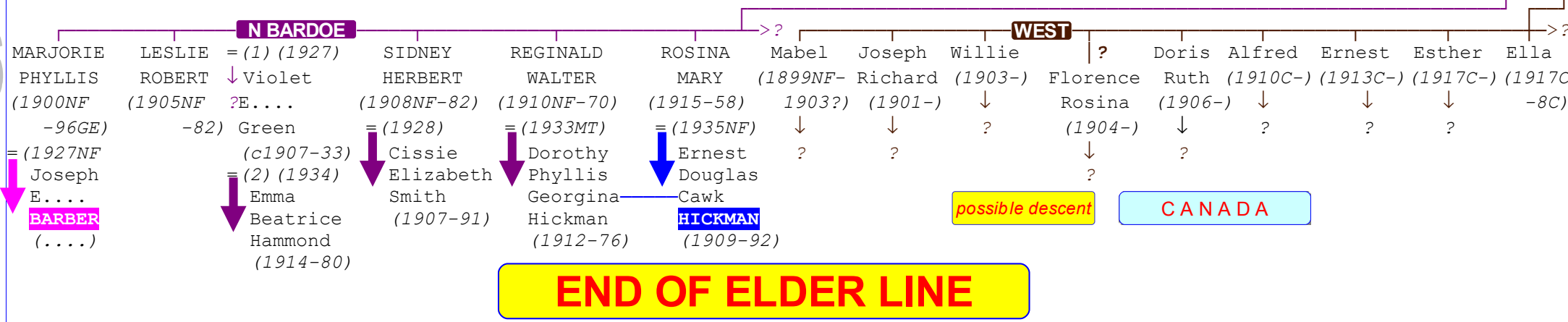

**YOUNGER LINE**  
**JOSEPH BARDOE I's FAMILY**

3  
4

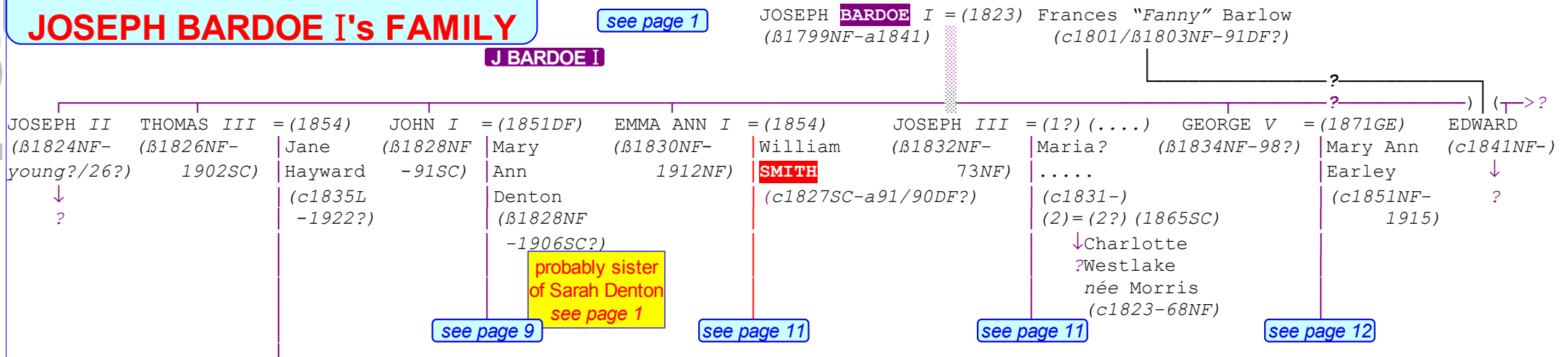

5

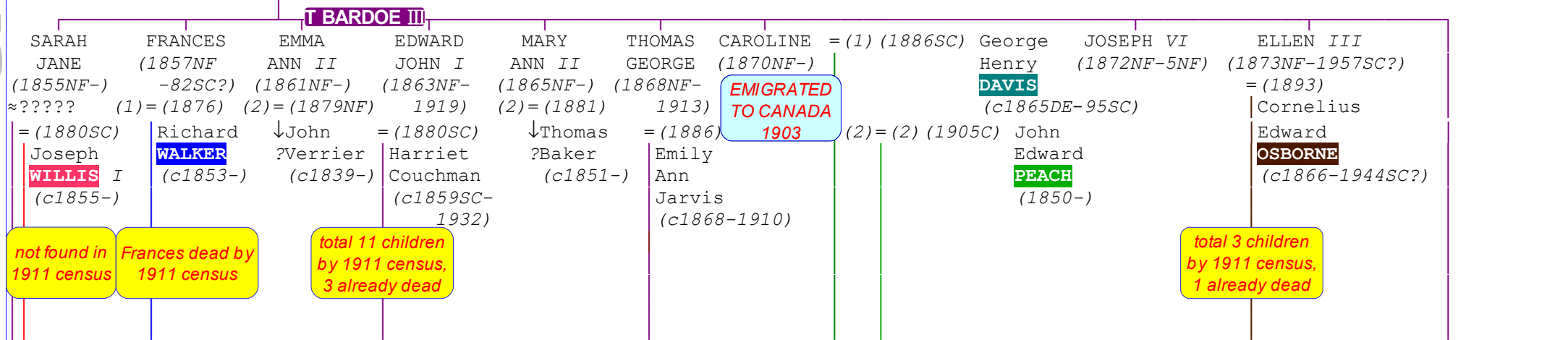

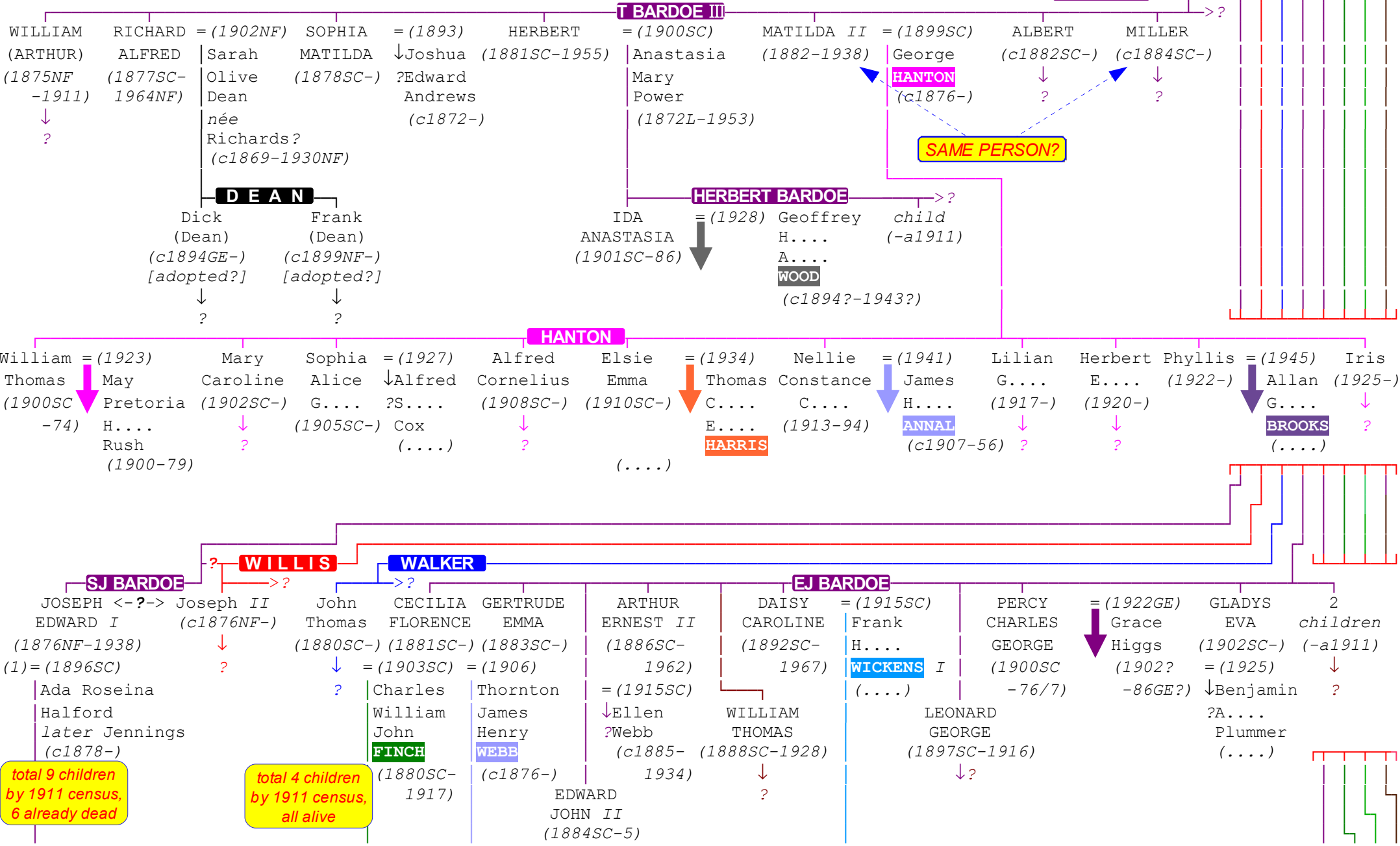

5

6

6

6

total 9 children by 1911 census, 6 already dead

total 4 children by 1911 census, all alive

7

**JE BARDOE I**

**FINCH**

**WICKENS  
WEBB**

LOUISA (1900-8)	JOSEPH EDWARD II (1902L-6)	JOHN STEPHEN (1906L-62)	ELIZABETH CHARLOTTE (1908SC-)	HELEN R.... (1911SC-)	SYDNEY JAMES (1915SC-80)	DORIS I.... (1917SC-)	GEORGE ROBERT (1920SC-)	Cecilia Florence (1903SC-)	William Charles (1905-83)	Edward John (1907-)	Annie L.... (1912-)	Kathleen G.... (1916-)	Laura Florence (1918-98)
3 children (-a1911)	ADA ROSEINA (1904L-6)	Amy M.... Hoadley (....)	William J.... WALLER (....)	Peggy E.... Russell (1921-48)	Fred BAKER (....)	Joyce L.... Swain (....)	?	Lydia Alice Isabella Lingham (1906GE-81GE)	Leslie Arthur (1910-)	Arthur E.... (1914-)	Harry Smith (....)	Herbert PLUME (1916-88)	

7

**WEBB**

**WICKENS**

child (-a1911)	William Alfred (1909SC-)	Jack (1911SC-)	Doris W.... (1914-)	Nellie E.... (1915-)	Edward J.... (1917-)	Ethel M.... (1921-)	Daisy C.... (1915SC-)	Frank Harold II (1919SC-84)
	?	?	?	?	?	?	?	?

6

**TG BARDOE**

**OSBORNE**

LOUISA EMILY ANN (1888SC-)	= (1913NF) Benjamin BUTCHER (....)	EDWIN JAMES CORNWALL (1890SC- 1957)	(1)= (1913) Caroline Russell later Smith (....)	EMILY ALICE ELIZABETH (1894SC- 1978)	= (1912) George ELVY (....)	GEORGE RICHARD CHARLES (1896SC-)	2 children (-a1911)	Nellie Ada Jane (1894SC- 1961DF)	= (1920) Walter J.... HICKS (....)	Alfred Thomas (c1898SC-)	child (-a1911)
-------------------------------------	---	---	--	--	--------------------------------------	---	---------------------------	--	--	--------------------------------	-------------------

7

**BUTCHER**

**EJC BARDOE**

**ELVY**

Emily M.... (1914NF-)	Edith C.... S.... (1920NF-)	ELSIE E.... (1913-)	SOPHIA E.... (1914-)	= (1936) William J.... CHANDLER (....)	LUCY MINNIE (1916- 2000)	= (1) (1936) Stuart Aram (....)	= (2) (1954) David Randle (....)	EDWIN T.... (1919-23)	George A.... W.... (1916-)	= (1948) Grace H.... Hawkes/ Rumbol (....)	William T.... (1918-)	Harry C.... (1920-5)
-----------------------------	--------------------------------------	---------------------------	----------------------------	--	-----------------------------------	--	---	-----------------------------	-------------------------------------	---	-----------------------------	----------------------------

CAROLINE AND HER 2 YOUNGER CHILDREN EMIGRATED TO CANADA 1903 - THE 2 OLDER CHILDREN HAVE NOT BEEN FOUND IN THE PASSENGER LISTS, SO PERHAPS THEY WENT AT A DIFFERENT TIME

6

**GHR DAVIS**

**PEACH**

Beatrice Mildred (1887SC-)	= (1909C) John SPENCER (c1888-)	George Edward John (1888SC-)	= (1909C) Helen Pesden (1886-)	Albert (1893SC-)	= (1919C) Agnes Cahill (c1894C?-)	Elsie Elizabeth (1895SC-)	= (1916C) Robert D.... Elliott (c1890-)	Caroline Lillian (1906C-)	= (1926C) Earl Bramwell Fidler (c1897-)	William Cowpe? (1908C-)
----------------------------------	--	---------------------------------------	---	---------------------	--	---------------------------------	---	---------------------------------	---	-------------------------------



**SPENCER** ->?  
 Elliott  
 William  
 John  
 (1910C-)  
 ↓  
 ?

**GEJ DAVIS** ->?  
 George  
 Albert  
 (1910C-)  
 ↓  
 ?

**CANADA**

# JOHN BARDOE I's FAMILY

see page 6

JOHN **BARDOE** I = (1851DF) Mary Ann Denton  
 (B1828NF-91SC) (B1828NF-1906SC?)

## J BARDOE I

JOHN III (1852SC-96) = (1873SC) Mary Teed Bristow (1848-98SC)	WILLIAM (1?) = (1877) WILBERFORCE (1854NF-1908GE)	MARY ANN I (1857SC-69) Ann Keziah Cooper later Fitt? (c1855SC-)	FLORA (B1863SC-1903) John BUGGS (1860-)	HARRIET (B1863SC-1933) Charles Wilkinson (c1857/9L-1937SC)	CLARA (1865SC-) = (1889SC) William TOWNSEND I (c1858-)	EMILY II = (1886NF) (1866NF-1932?) Walter COOK (c1860L-)	GEORGE = (1891) ARTHUR (1869SC-1953GH) Emmeline Agnes Baker (1869DF-1954)	HENRIETTA (1871SC-98) = (1895) Thomas Charles Edwards (....)
---	---	---	--	---	--	---	---	--

**EMIGRATED TO CANADA**  
 ..., 1911, 1907

total 10 children by 1911 census, 7 already dead, but including 2nd marriage?

no children by 1911 census

total 6 children by 1911 census, all alive

total 9 children by 1911 census, 3 already dead

total 5 children by 1911 census, all alive

not found in 1911 census

**GA BARDOE COOK TOWNSEND**

## J BARDOE III

## WW BARDOE

## J BUGGS

JESSIE ALICE MARIA (1874SC-77)	EMILY MAUD (1880SC-1963C)	GEORGE STANLEY BRISTOW (1882SC-1913C)	ROSAMUND KATHERINE MARY (1884SC-1979C)	MABEL GERTRUDE (1878SC-1900GE)	STANLEY WILLIAM I (1880SC-1955)	GRACE VICTORIA BEATRICE (1885SC-1978)	John Frederick (1884SC-)	George Arthur (1885SC-1910)	Mary Victoria J.... (1887SC-1904)	Florence Lilian (1889SC-)	Violet May (1892SC-1906)	Queenie (c1895SO-)
WILLIAM ALFRED (1876SC-79)	George Owen (1879-1936C)	Lilian Kate Brigstock (....)	Matthew BUTLER (1885-1969C)	Arthur Edward GREEN (c1877GE-)	Florence Rosalie Harris (c1885GR-1965)	Robert Charles TURNER (....)	Elizabeth S(arah?) Trevillion (c1893?/4?-)	James William (1890SC-91SC)	William Harry (1893SC-)	Clara Victoria J.... (1897SO-1902)	Peearay (?) (c1903DF-)	

## TUFNAIL

## GSB BARDOE

## BUTLER

## GREEN

## GA BUGGS TURNER

## SW BARDOE

George Stanley (1905-84C)	Roland Owen (1907SC-)	Walter Owen (c1912-78C)	GEORGE S.... (1914)	Norris (1907?C-)	Violet (1908C-)	Rosamund E.... (1914-)	Norah Gertrude (1900GE-)	Geoffrey (c1905GE-)	Josephine Mary (c1909GE-)
------------------------------	--------------------------	----------------------------	------------------------	---------------------	--------------------	---------------------------	-----------------------------	------------------------	------------------------------

**CANADA**

**CANADA**

4  
5

6

7

7

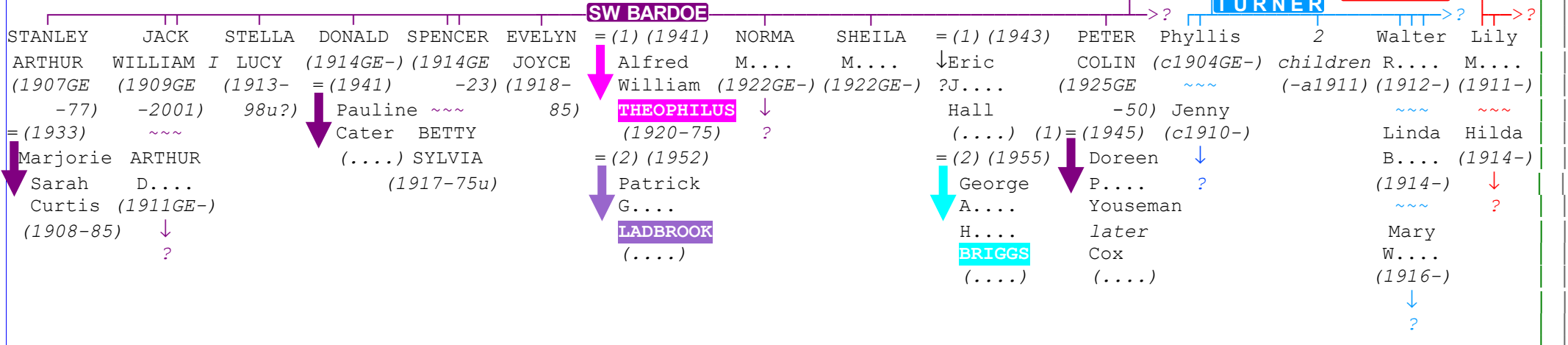

6

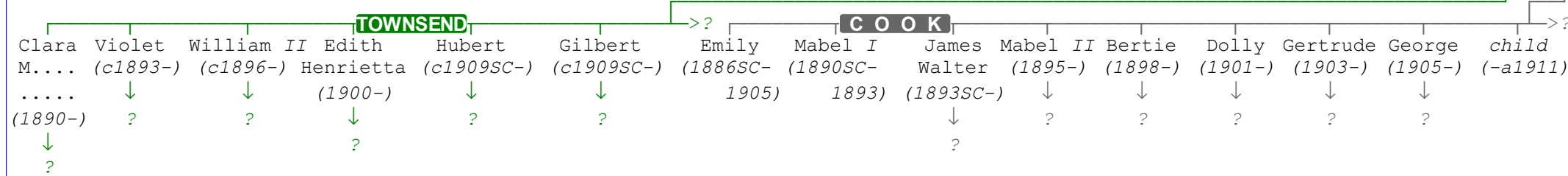

6

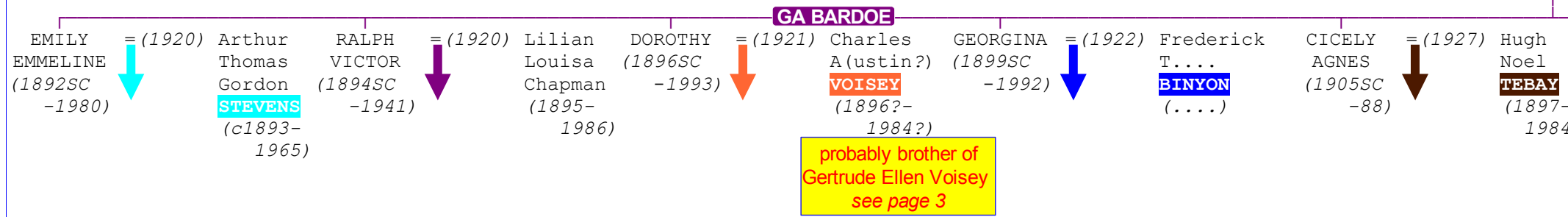

# EMMA ANN BARDOE I's FAMILY THE SMITH FAMILY

see page 6

EMMA ANN **BARDOE** I = (1854) William **SMITH**  
(B1830NF-1912NF) (c1827SC-a91/90DF?)

## W SMITH

George Edward (1856NF-97L?)	=? (1881NF) Margaret Stedman (c1854GE-)	Henry Frederick (1858NF-)	= (1880NF) Belinda Florence (c1856NF-88)	Ellen A.... (1860-)	= (....) John <b>PAGE</b> (c1861GE-)	Alice (c1863-)	William T.... (c1865-u?)	Joseph (1) (c1867-92NF?)	= (1886GE) Emily Clara Edgeler later Watson (c1867NF-)	Albert George (1869NF-)	= (1906?) Emma Eliza (Cook?) (c1873-)	Percival St. Botolph (1872NF-98NFu?)
--------------------------------	---	------------------------------	--	------------------------	--	-------------------	-----------------------------	-----------------------------	---	----------------------------	--	---

dead by 1911 census

not found in 1911 census

total 6 children by 1911 census, 2 already dead

dead by 1911 census

total 1 child by 1911 census, alive

## AG SMITH

## GE SMITH

## HF SMITH

## J PAGE

## J SMITH

Stanley (1883-)	Ellen Isabel (1881NF-)	Harry F.... (c1886NF-)	Albert (1888)	John Cedric (1887NF-)	Doris Ellen (1890NF-)	Roy John (1893NF-)	Bessie Isabel (1900NF-)	child (-a1911)	Edith E.... (c1887NF-)	Sybil Cecilia (1888NF-)	Ada Elizabeth (1889NF-)	Alice L.... (1890SC-)	Margaret Alice (c1907SC-)
=? (1909GE)	(1881NF-)	(c1886NF-)	(1888)	(1887NF-)	(1890NF-)	(1893NF-)	(1900NF-)		(c1887NF-)	(1888NF-)	(1889NF-)	(1890SC-)	(c1907SC-)
↓ Ellen ?Smith (c1883GE-)	↓ ?	↓ ?		= (1909) Elizabeth Selina Jane Willett (1887-1979)	Grace Adelaide (1891NF-)	= (1918GE) Sophia Hogwood (c1886/7-p1950/1966?)	↓ ?		↓ ?	↓ ?	↓ ?	↓ ?	↓ ?

no children by 1911 census

## JC PAGE

## RJ PAGE

Harold J.... C.... (1914-)	Bessie M.... (1919-)
----------------------------------	-------------------------

# JOSEPH BARDOE III's FAMILY

see page 6

JOSEPH **BARDOE** III = (1?) (....) Maria? ..... (2)=(2?) (1865SC) Charlotte Westlake née Morris (c1823-68NF)

something may be wrong here

## J BARDOE III

MARY M.... (c1851L-)	EMILY I (c1852L-)	AGNES (c1855L-)
↓ ?	↓ ?	↓ ?

5

6

7

4

5

# GEORGE BARDOE V's FAMILY

see page 6

GEORGE **BARDOE** V = (1871GE) Mary Ann Earley (1834NF-98?) (c1851NF-1915)

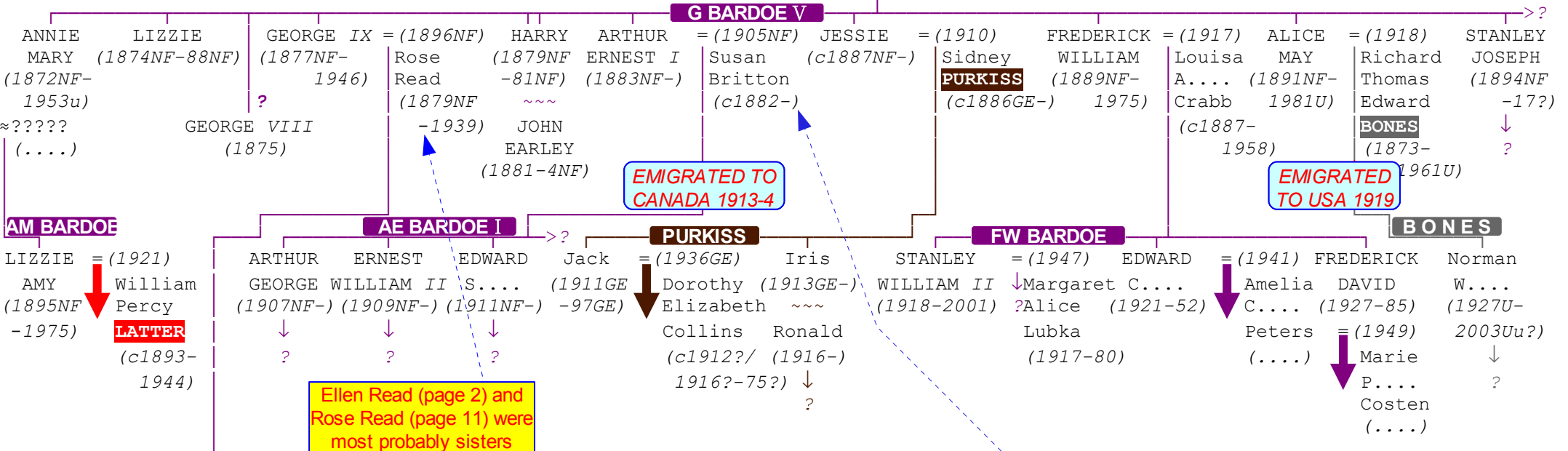

Ellen Read (page 2) and Rose Read (page 11) were most probably sisters

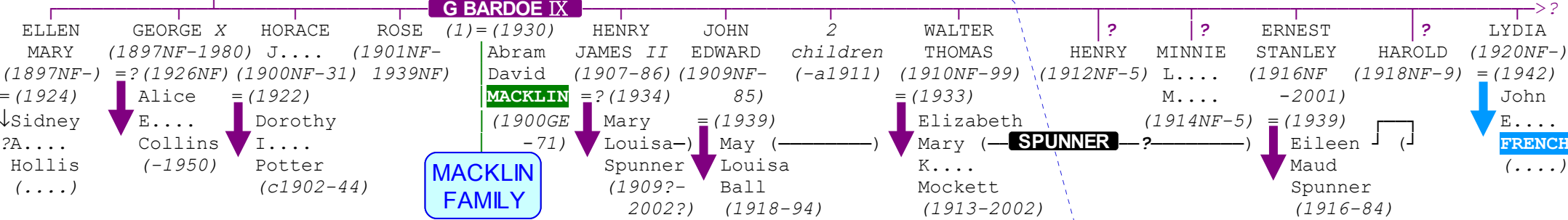

## "STRAY" BARDOES

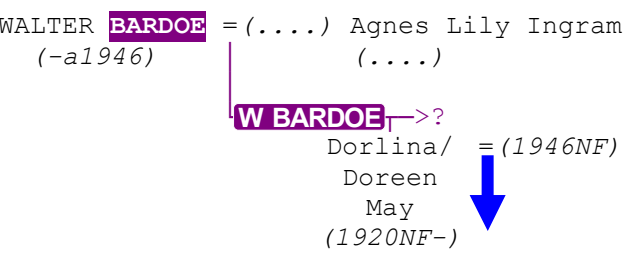

This may be Walter Bardoe (1867-1923), son of Thomas Bardoe IV, but there are no Bardoe/Ingram marriages in the records, and Walter was unmarried in 1911

Ada Britton, Lily Mary Britton (both page 4), and Susan Britton (page 10) a were most probably sisters

**C** Canada  
**CH** Cobham, Kent  
**DE** Deptford, Kent  
**DF** Dartford, Kent  
**GE** Gravesend, Kent  
**GH** Gillingham, Kent  
**GW** Greenwich, Kent  
**L** London, Middx  
**MT** Milton-next-Gravesend, Kent →? not known whether any other children  
**NF** Northfleet, Kent  
**SC** Swanscombe, Kent  
**SO** Sevenoaks, Kent  
**ST** Strood, Kent  
**TW** Tunbridge Wells, Kent  
**U** USA

**β** baptized (exact year of birth not known)  
 = married      ≠ divorced  
**c** approximately    **a** before      **p** after  
**u** (after date of death) unmarried  
**(1) (2)** (for marriages) firstly, secondly, etc.  
           (for children) first, second born, etc.  
 ↓ not known whether any children  
 ?

DURHAM@TELETU.IT  
**COMMENTS AND CORRECTIONS WELCOME**

### PAGE LAYOUT

Figures in red are the family htm pages

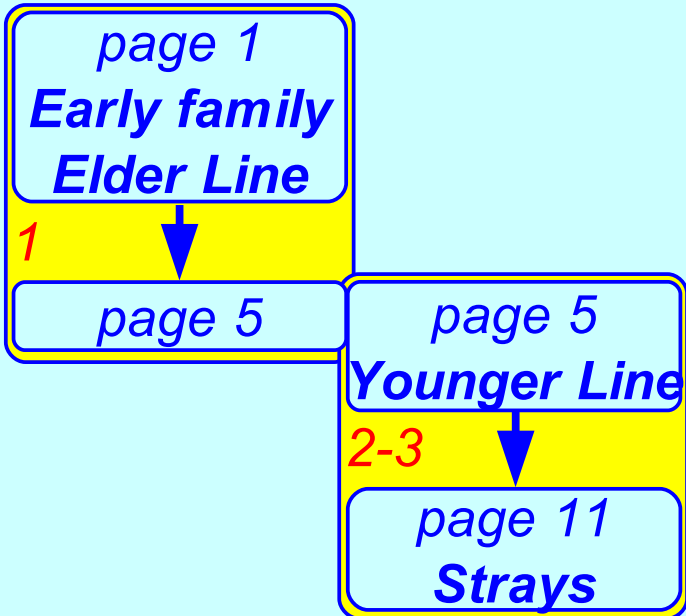

### NOTES

[1] As of 18 FEBRUARY 2014 almost all **Joseph Bardoes** have been renumbered

JOSEPH BARDOE β1799-1834?/before 1841, I no change  
 JOSEPH BARDOE β1824-1826?/died young?, from IIa to II  
 JOSEPH BARDOE β1832-1908, from IIb to III  
 JOSEPH BARDOE β1834-1873, from III to IV  
 JOSEPH BARDOE 1858-1910, from IV to V  
 JOSEPH BARDOE 1859-1942, from V to VI – now Charles Joseph  
 (JOSEPH BARDOE VII/VI 1872-5, is new)

[2] As of 12 MARCH 2014 the families of some Joseph Bardoes have been revised.

so any previous family situations should be ignored

[3] As of 4 APRIL 2014 some later **George Bardoes** have been renumbered

GEORGE BARDOE I-VII no change  
 GEORGE BARDOE 1875-75, VIII new  
 GEORGE BARDOE 1877-1946, from VIII to IX  
 GEORGE BARDOE 1897-1960, from IX to X